

INSTRUCTIONS FOR C-giant

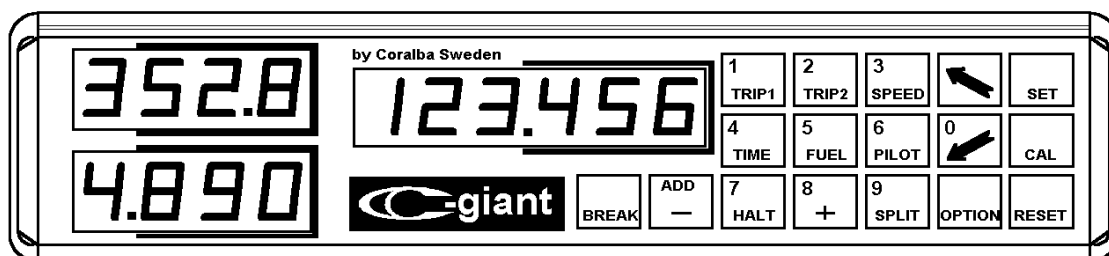

Option: C-view

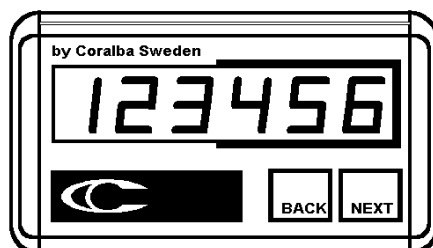

Jemba ab

Väpnarv. 10, SE-691 53 KARLSKOGA, Sweden
Tel: +46-(0)586-55640, Fax: +46-(0)586-31451, E-mail: info@jemba.se

GB

TABLE OF CONTENTS

	Page
TABLE OF CONTENTS.....	2
1. GENERAL.....	3
2. FITTING C-GIANT.....	4
2.1. Fitting the instrument.....	4
2.2. Fitting the pulse generator.....	4
2.3. Fitting PGE.....	5
2.4. Fitting high temp sensor PGH (DP210).....	5
2.5. Fitting universal pulse generator (DP013).....	6
2.6. Electrical connections.....	7
2.6.1. Connections for yellow remote control.....	8
2.6.2. Connections for fuel.....	8
3. SAFETY ASPECTS.....	8
4. FUNCTION.....	9
4.1. Power ON/OFF.....	9
4.2. Summary of functions.....	10
5. OPERATION.....	17
5.1. Distances measurement (Trip 1, Trip 2 and Trip 3).....	17
5.1.1. Pre-set.....	17
5.1.2. Align trip to road book.....	17
5.1.3. Memory register.....	17
5.1.4. Automatic SS measurements.....	18
5.1.5. Estimated time of arrival.....	18
5.2. Speed measurement (SPEED).....	19
5.2.1. Speed threshold (OPTION).....	19
5.3. Set.....	20
5.4. Time measuring (TIME).....	20
5.4.1. Set time.....	20
5.4.2. Adjust time.....	21
5.5. Fuel gauge (FUEL).....	21
5.6. Monitoring average speed (PILOT).....	22
5.7. Calibrate C-giant, distance (CAL).....	23
5.8. Calibrate C-giant (TIME).....	24
5.9. Calibrate C-giant (FUEL).....	24
5.10. Set up units in C-giant.....	26
5.11. Split.....	27
5.12. Option.....	27
6. ERROR CODES.....	30
7. INDEX.....	31

1. GENERAL

Edition 7 December 2000

C-giant is used for measuring during rallies. It is an indispensable instrument for the professional co-driver. The instrument has been developed by Coralba after many years of experience of a co-drivers special needs in his stressful situation. Therefore C-giant has all the functions that will make a co-driver perform his duties **RAPIDLY, SECURELY** and **EFFICIENTLY**.

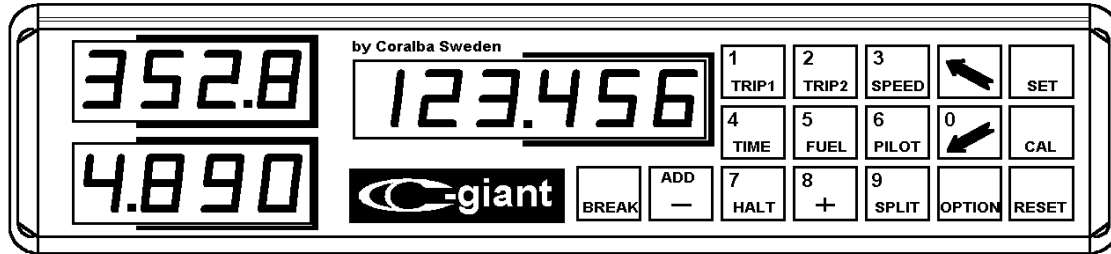

It is basically a distance- and speedo-meter for the car. Furthermore it has a lot of useful processing facilities for the co-driver. The precision of the instrument is reached by an effective but simple calibrating procedure. After calibration C-giant shows correct values to a tolerance typically better than 0.03%.

C-giant can also work as a precision fuel gauge just by connecting the instrument to the standard fuel sender of the car and calibrating it in a simple way.

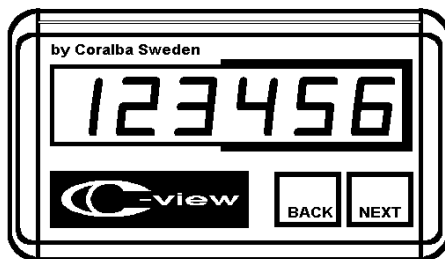

C-giant is available with a communication connector (option) where you may connect a number of remote display units (C-view), speed threshold indicator or a computer. Any combination may be used at the same time.

A complete C-giant set consists of:

- instrument
- cables
- pulse generator with a universal mounting kit
- documentation

NOTE! For some cars the universal mounting kit is substituted with a special adapter for the pulse generator or an electronic interface. Check before mounting the C-giant that you have got the correct parts for your car.

2. FITTING C-GIANT

2.1. Fitting the instrument

Fitting the C-giant into the vehicle is extremely simple. First you have to fit the instrument itself. Fitting of C-giant in the vehicle compartment is done with its two fastening bolts (M4x10) at the back of the unit. The bolts may be exchanged to any other M4 bolts providing they are the same length.

2.2. Fitting the pulse generator

The pulse generator may be of different types:

- Interface for a car with electronic speedometer (PGE-..)
- Proximity switch pulse generator (PGH)
- Rotating pulse generator with universal mounting kit (DP013)

Depending which type is required for your car the pulse generator is fitted in different ways.

2.3. Fitting PGE..

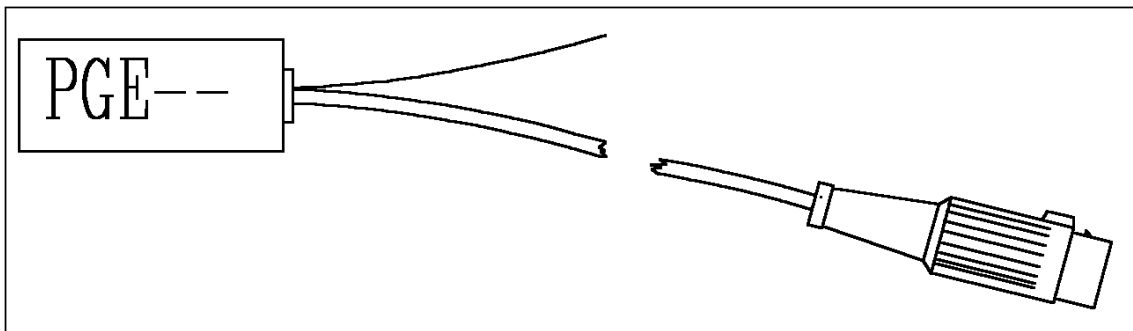

This interface is used in cars with electronic speedometer. It is connected to the original pulse generator of your car in accordance with a separate instruction.

2.4. Fitting high temp sensor PGH (DP210)

This pulse generator is used on cars where no speedometer is fitted as standard. It is generally fitted at a shaft, sensing bolts, splines or similar machined irregularities. Fit the

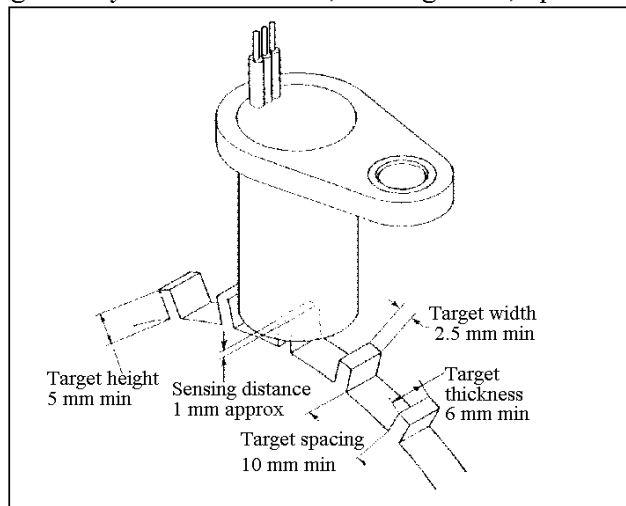

pulse generator so that it senses the targets when the car is running. It should be mounted so that it will sense between 1 and 100 targets per 10 m. At least one target per metre is preferable. The proximity switch pulse generator is sensitive to ferrous metal targets at its end. Therefore targets should be made from good magnetic material, such as cold rolled steel. If magnets are used as targets the sensing distance may be increased by a factor of about 3-4, depending on type of magnets. Avoid temperatures above 150° C.

Set calibration value to 10000 and select TRIP 1 to check the pulse generator. When the wheel is turned around. TRIP 1 should increase by 1 for every target passing the sensor.

2.5. Fitting universal pulse generator (DP013)

This pulse generator is fitted on the original speedometer cable by cutting it into two pieces and connecting the two parts together with the pulse generator. Select a place on the speedometer cable where it is fairly straight and cut away a part about as long as the length of the pulse generator. Cutting the cable is best done with the speedometer cable removed from the car. The position of the cut should preferably be at a place so that once the pulse generator is mounted it isn't exposed to water or oil.

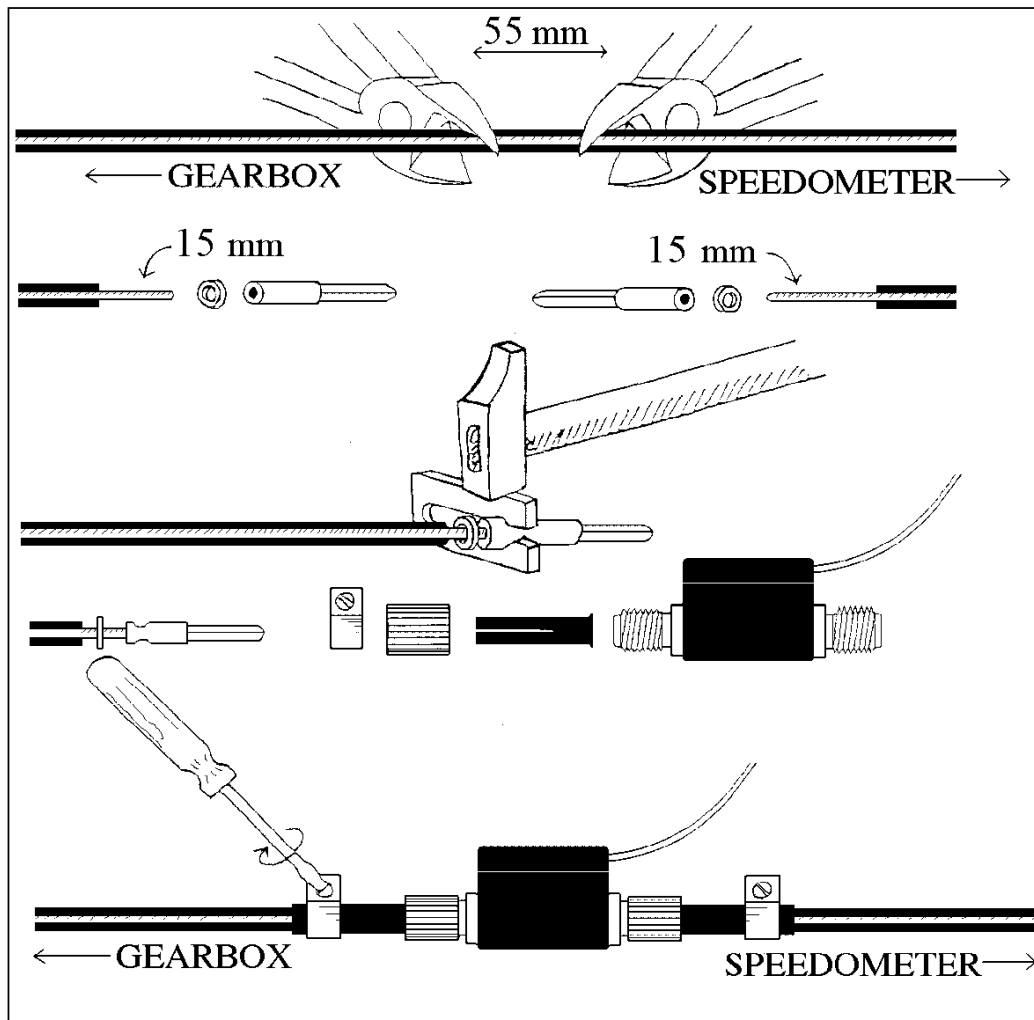

When removing the pulse generator from the vehicle you may replace it with a cable repair kit instead of changing the speedometer cable. The cable repair kit may be ordered from Jemba.

2.6. Electrical connections

Make sure great care is taken in connecting C-giant as damage may occur to the unit if it is connected incorrectly. The system should have negative ground.

- **Red** cable (power) is connected to +12 volt directly from the battery through a fuse of about 1 A.
- **Brown** cable is connected to the negative pole directly on battery.
- **Yellow** cable is connected to a reverse light so that the trip will be supplied with +12 volt when the car is driven in reverse. If this is not possible the yellow cable must be connected to ground. It may also be used as a programmable remote control.
- **White** cable may be connected to a remote reset button. TRIP 1 is reset to zero when the cable is connected to ground even if TRIP 1 is not shown in the display. No other register is influenced by this. It may also be used as a programmable remote control.
- **Black** cable is connected to the fuel gauge.

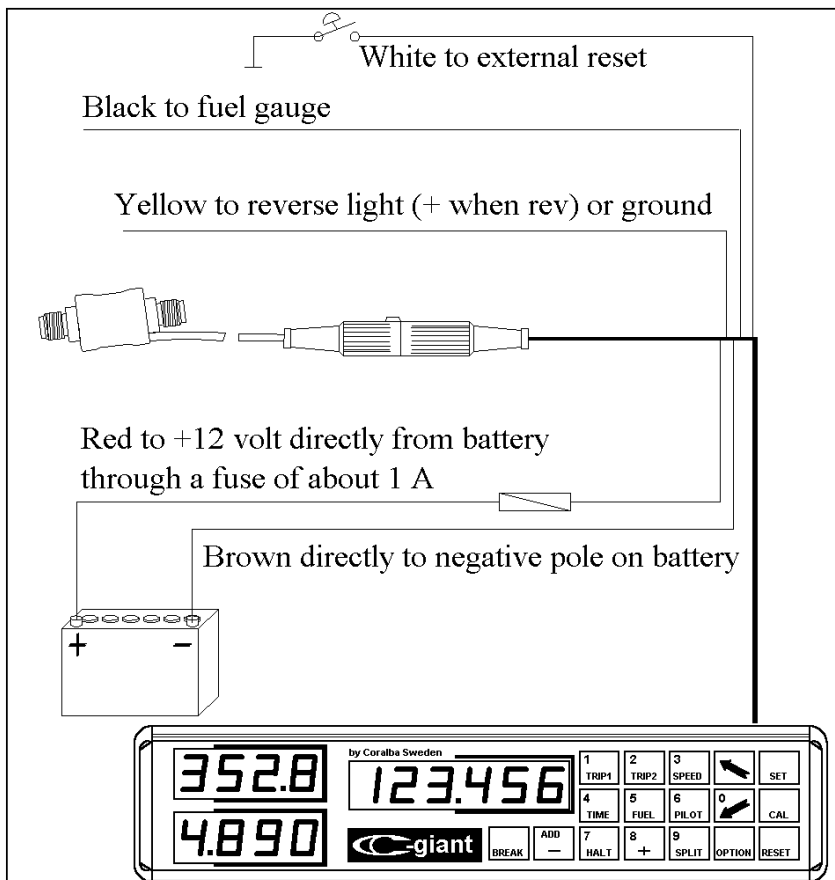

Make sure all connections are done professionally. The cables should be fixed to avoid damage. Most disturbances in function that occur are caused by poor connections to the power supply. After having carried out these functions simply connect each part together and you will be ready to use C-giant.

When the trip meter is connected it must be calibrated. See page 23 and page 24. When connecting the cable to the instrument, see to that the springs both go

into locking position.

2.6.1. Connections for yellow remote control

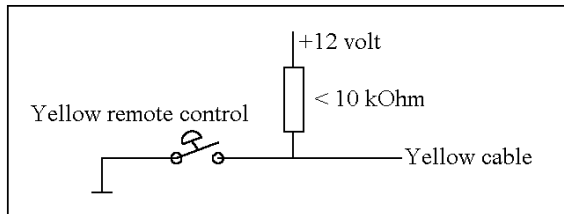

The yellow cable is meant to be connected to the reverse light as default. However you may define it as a remote control (See page 27). For this reason the remote control for the yellow cable should not be connected in the same way as for the white remote cable. It must have a pull up

resistor of max. 10 kohm. This may be ordered from Jemba.

2.6.2. Connections for fuel

The black cable should be connected to the standard fuel sender of your car. If you remove the standard fuel gauge you must fit a resistor instead of it. This may be ordered from Jemba. See page 24 for calibration.

3. SAFETY ASPECTS

Safety aspects concerning fitting of accessories inside a car must be taken in to account when fitting C-giant. The instrument must be fitted in a way that takes into account applicable laws and regulations and so that the risk of damages in the case of an accident is minimized.

4. FUNCTION

The panel has three display windows:

- The main display with six figures
- Upper left and lower left displays with four figures each.

The keyboard has four different kinds of keys:

- Selector keys: TRIP 1, TRIP 2, SPEED, TIME, FUEL, PILOT, CAL, OPTION which will select different registers and display its value in the main display.
- Operator keys: SET, ADD/-, HALT, +, RESET which will operate on the value in the selected register.
- Display keys: Arrow up, Arrow down, SPLIT which will operate on the display mode.
- Numeric keys: 0–9 which will switch to their numeric functions automatically when a numeric input is required.

Furthermore a BREAK key will always bring you back to a default setting of the mode of operation.

The basic philosophy for C-giant is that when you press any of the keys you do not influence any other register in the instrument other than the one that you see in the main display. The register in the main display is called the current register. While pressing a key to select a new register the main display shows a flash text telling you which current register will be shown next. Some keys have more than one register. They are selected by repeatedly pressing the key.

4.1. Power ON/OFF

When the instrument is not in use it will automatically switch itself into an idling mode where the display and the keyboard are totally dark. When C-giant is operated or the car is moved it is automatically turned on again. If for some reason you want to have the display turned off while driving - just press TRIP 1 twice. See page 17.

4.2. Summary of functions

C-giant has the following functions:

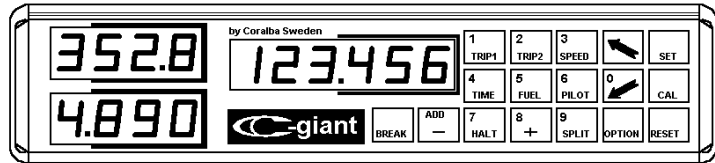

Key	Function	Appropriate keys
Flash text		
TRIP 1		
.triP..1 <i>EtA.P..1</i>	Trip meter with a resolution of 1 metre See page 13.	SET, CAL, -, HALT, +, SPLIT, RESET
.MEMory <i>MEMORY</i>	Memory register. This register may be used as 'DISPLAY OFF'. See page 13.	SET, SPLIT, RESET
TRIP 2		
.triP..2 <i>EtA.P..2</i>	Trip meter with a resolution of 1 metre See page 13.	SET, CAL, -, HALT, +, SPLIT, RESET
.SS.Hour <i>SSHour</i>	Period of time since .triP..2 started to count from zero. See page 18.	SPLIT
.A.SPEEd <i>ASPEEd</i>	Average speed since .triP..2 started to count from zero (page 18), OR required average speed to keep target time on section if target time is put into .EtA.A. See page 18.	SPLIT
.toP.SPd <i>toPSPd</i>	Maximum speed since .triP..2 started from zero or .toP.SPd was reset. See page 18.	RESET, SPLIT
.EtA.diS <i>EtAdiS</i>	Distance to use when estimating time of arrival. See page 18.	SET, SPLIT
.EtA.-A. <i>EtA-A</i>	Estimated time of arrival at .triP..2 = .EtA.diS if .A.SPEEd is kept. See page 18	SET, SPLIT
<p>NOTE!!! <i>"SET" may be used to set a target time for the current section. In this case .A.SPEEd will show required average speed to keep target time, .EtA.Cur will show your current margin in time (plus or minus) and the indicator in the button will flash.</i></p>		
.EtA.Cur <i>EtACur</i>	Estimated time of arrival at .triP..2 = .EtA.diS if current speed is kept or margin in time. See page 18.	SET



Key	Function	Appropriate keys
Flash text		
(TRIP)+CAL		
.CAL.diS	Calibrate distance if trip or speed is selected.	SET, SPLIT,
.CAL.di S	Second touch will show ".CALib." in display and then ".drive." telling to drive reference length. Press "SET" at end of reference length and set the length of the calibrating distance. RESET will give access to a set up mode for different units. See page 26.	RESET
SPEED		
.SPEEd.	Speedometer. It is also possible to set the	SET, CAL,
.SPEEd	scheduled speed for the "PILOT". See page 13.	SPLIT
.triP..3	Trip meter with a resolution of 1 metre	SET, CAL, -,
.tri P. 3	See page 13.	HALT, +, SPLIT,
.SPd.thr	Speed threshold to get a warning against speeding (option). See page 19.	RESET
.SPd.thr		SET, SPLIT
ARROW UP		
.SELEct.	Copies the current register into the upper	SPLIT
.SELEctE	left display. See page 13.	
.ShiFt.1	Scrolls upper left display one figure right	SPLIT
.Shi Ft. 1		
.ShiFt.2	Scrolls upper left display two figures right	SPLIT
.Shi Ft. 2		
TIME		
.Hour..1	Clock with a format of 23.59.59 and a	SET, CAL, -,
.Hour. .1	resolution of 1 s. See page 14.	HALT, +, SPLIT,
		RESET
.Hour..2	Clock with a format of 59.59.95 and a	SET, CAL, -,
.Hour. .2	resolution of 0.05 s. See page 14.	HALT, +, SPLIT,
		RESET

Key	Function	Appropriate keys
(TIME)+CAL .CALib. <i>.CALi b</i>	Calibrate time if time is selected. See page 24.	SET, -, +, RESET
FUEL ..FUEL. . <i>.FUEL</i>	Amount of fuel left. When driving the value is filtered to stabilise the read out. Values from the last 99 km's may be read by using + and - buttons. See page 14.	CAL, SPLIT, -, +
(FUEL)+CAL .CALib. <i>.CALi b</i>	Calibrate Fuel if fuel is selected. See page 24.	SET, RESET
PILOT ..Pilot. . <i>.Pilot</i>	Time ahead or delayed in respect to the scheduled average speed. Scheduled speed is set in the SPEED-mode. See page 14.	SET, -, HALT, +, SPLIT, RESET
<i>NOTE!!! The -, HALT and + button only affects the distance for this calculation</i>		
ARROW DOWN ..SELEct. <i>.SELEct</i>	Copies the current register into the lower left display See page 14.	
.ShiFt.1 <i>.Shi Ft 1</i>	Scrolls lower left display one figure right	
.ShiFt.2 <i>.Shi Ft 2</i>	Scrolls lower left display two figures right	
OPTION ..OPtion <i>.OPti on</i>	Definition of functions for the two programmable inputs. The indicator is on when at least one input is defined. See page 16.	SET, RESET, SPLIT
.WhitE <i>.Whi tE</i>	Remote function connected to white cable is selected to be defined	SET, RESET
.yellow <i>.Yellow</i>	Remote function connected to yellow cable is selected to be defined.	SET, RESET

A short description is given for every key from upper left to lower right on the key board. Detailed applications on how to operate each function will follow.



TRIP 1, TRIP 2, TRIP 3

Registers with a resolution of 1 metre . Press the appropriate key to select and see value, and to change its function. Flash text (.trip..1) and a led indicator shows that the function is selected. TRIP 2 also has several functions including automatic SS-measurement, (See page 18) and a function for estimating time of arrival (See page 18). TRIP 3 is selected by pressing SPEED twice. Flash Text (.trip..3).

Selectable keys: ARROW UP, SET, ARROW DOWN, CAL, -, HALT, +, SPLIT, RESET.

By pressing TRIP 1 twice you will select a **memory** register. It is a general purpose numeric register but it will be blank when 'RESET' is pressed. It is the only way to get a blank display while driving. Flash Text (.MEMory). See page 17 for operation.

Selectable keys: ARROW UP, SET, ARROW DOWN, RESET.

SPEED

SPEED shows the speed of the vehicle. Flash text (.SPEEd.) and led indicator show that the function is selected. This register is also used to input scheduled speed for the PILOT. See page 14

Selectable keys: ARROW UP, SET, ARROW DOWN, SPLIT.

TRIP 3 is selected by pressing SPEED twice. Flash text (.trip..3) and led indicator show that the function is selected.

Speed threshold is selected by pressing the SPEED key three times. Flash text (.SPd.thr) and flashing led indicator show that the function is selected. The value can be set by the normal SET procedure. See page 20.

ARROW UP

ARROW UP will copy the current register into the top left window. Flash text (.SELEct). Repeated pressing will scroll the display one figure at a time to the left to give access to the desired figures. Flash text (.ShiFt.1) and (.ShiFt.2).

SET

SET is used to start the input of a value to the register that is shown in the display. See page 20.

SET may be used together with TRIP 1 (.trip..1), TRIP 2 (.trip..2, .EtA.diS, .EtA.-A.), SPEED (.SPEEd., .trip..3, .SPd.thr), TIME (.Hour..1, .Hour..2), PILOT (.Pilot.), CAL (.CAL.diS, .CALib.), OPTION (.WhitE, .Yellow).

SET is also used for adjusting a value in a register. See page 20

This function may be used together with TRIP 1 (.trip..1), TRIP 2 (.trip..2, .EtA.diS, .EtA.-A.), SPEED (.trip..3, .SPd.thr), TIME (.Hour..1, .Hour..2), PILOT (.Pilot.), CAL (.CAL.diS).

Selectable keys: numeric keys, -, RESET.

TIME

TIME has two time registers which may act as an ordinary clock or a stop watch. They can count forwards and backwards. Flash text (.Hour..1) or (.Hour..2) and led indicator show which function is selected. Hour 1 has a resolution of 1 second and hour 2 has a resolution of 0.05 seconds. See page 20 for time measurement and page 24 for calibration. Selectable keys: ARROW UP, SET, ARROW DOWN, CAL, -, HALT, +, SPLIT, RESET.

FUEL

FUEL shows amount of fuel left in the tank. See page 21. It may be calibrated to the standard fuel gauge of your car (See page 24). Flash text (.FUEL.) and indicator show that the function is selected.

Selectable keys: ARROW UP, ARROW DOWN, CAL, -, +, SPLIT.

PILOT

PILOT shows your time ahead or delayed in respect of your scheduled average speed. Flash text (.Pilot.) and led indicator show that the function is selected. See page 22.

Selectable keys: ARROW UP, SET, ARROW DOWN, -, HALT, +, SPLIT, RESET.

ARROW DOWN

ARROW DOWN will copy the current register into the bottom left window. Flash text (.SELEct). Repeated pressing will scroll the display one figure at a time to the left to give access to the desired figures. Flash text (.ShiFt.1) and (.ShiFt.2).

CAL

CAL may be used when TRIP 1, TRIP 2, TRIP 3 or SPEED are selected to show the current CALIBRATING CONSTANT for distance. Flash text (.CAL.diS) and led indicator show that the function is selected. The constant may be changed with the SET function. See page 20. By pressing 'RESET' the C-giant enters a set up mode where different units may be defined for distance, speed, temperature and communication. See page 26.

Selectable keys: ARROW UP, SET, ARROW DOWN, RESET.

The CAL function can also be used when TIME is selected. Then it will calibrate the time counting. See page 24. Flash text (.CALib.) and led indicator show that the function is selected.

Selectable keys: SET, -, +, RESET.

If CAL is used when FUEL is selected a sequence is started that will calibrate the FUEL function. See page 24. Flash text (.CALib.) and led indicator show that the function is selected.

Selectable keys: SET, numeric keys, RESET.



BREAK

BREAK will reset the instrument to a defined status. This function must not be used as a normal resume function but as an emergency action if you must abort a started sequence. It is also used to start the instrument if a power failure has hang up the instrument. This may happen if power is intermittent.

ADD/-

Reverse counting direction (-). Flash text (.nEG.dir) and led indicator shows that the function is selected. NOTE! This function influences only the register that is currently shown in the display. This function may be used together with TRIP 1, TRIP 2, TRIP 3, SET, TIME, PILOT.

If 'FUEL' is selected this key allows you to view the fuel values for the past 99 km's in 1 km increments by repeatedly pressing '-'. See page 21

In SET mode '-' will be interpreted as a minus sign if it is the first key after 'SET' otherwise it is interpreted as 'ADD'. See pages 20 and 20.

HALT

HALT will stop the current register from counting. This function is also used to add several intervals. Flash text (.HALt.) and led indicator shows that the function is selected. This function may be used together with TRIP 1, TRIP 2, TRIP 3, SET, TIME, PILOT.

POSITIVE (+)

POSITIVE counting direction (+). Flash text (.PoS.dir) and led indicator shows that the function is selected. This function may be used together with TRIP 1, TRIP 2, TRIP 3, SET, TIME, PILOT.

This key is also used to view the fuel values for the past 99 km's in 1 km increments. See page 21.



SPLIT

SPLIT will freeze all registers values simultaneously permitting later inspection. All functions will carry on their counting. Flash text (..SPlit.) and led indicator shows that the function is selected. Second touch at 'SPLIT' will disable the freeze function and show current values.

This function may be used any time during normal operation - not in SET or calibration mode.

OPTION

OPTION allows the user to define which functions are carried out when the two remote cables (white and yellow cable) are activated. Flash text (.OPtion). See page 27 for definition and pages 7 and 8 for connection.

RESET

RESET will set current register to zero. Flash text (.rESEt.). This function may be used together with TRIP 1, TRIP 2, TRIP 3, TIME, PILOT, OPTION.

In SET mode this key will restore the previous value.

5. OPERATION

5.1. Distances measurement (Trip 1, Trip 2 and Trip 3)

When measuring distances C-giant has got three registers for this purpose, TRIP 1, TRIP 2 and TRIP 3. They may be used individually with separate counting directions plus (+) or minus (-). 'HALT' will stop the current register. 'SPLIT' freezes the values of all registers. If the measurement is to be done in the negative direction you just press the (-) key. If the yellow cable is connected to the reverse light the trip meters automatically switch counting direction when the vehicle is going in reverse.

5.1.1. Pre-set.

If you want to start measuring from a point at a known distance it is easy to set that value into a trip register. Select the trip to be used (TRIP 1, TRIP 2 or TRIP 3), press the SET button and feed the value into the register with the numeric keys 0 - 9. The input is confirmed with the SET key. Now your measuring starts from the set distance. If you require the measurement to start from a negative value the figures must be preceded by a minus sign. If you change your mind it is possible to get the original value by pressing RESET instead of SET.

5.1.2. Align trip to road book

The registers may also be adjusted with an arbitrary value. See section SET. If a junction is passed at 43.67 km according to the road book but the trip shows a different value then it is easy to adjust the trip very accurately without stopping the car. Reset the trip at the junction. Carry on driving and press SET and input the desired value (43670) with the numeric keys. Finish the input with (ADD/-). When you terminate the input with the (ADD/-) key that means that the current value is to be adjusted with the input value. The result is that the measurement takes place from the junction with the correct value.

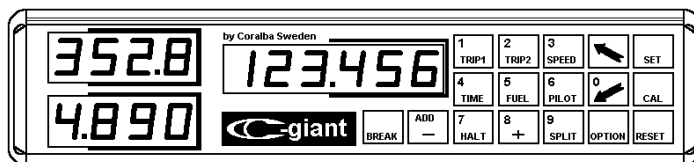

5.1.3. Memory register

Second touch of TRIP 1 will select a memory register. It is possible to set, add and subtract values in decimal format. RESET will set the display OFF. This is the only way to get a C-giant or C-view blank when driving. This blank window may be copied into all windows with the arrow keys.

5.1.4. Automatic SS measurements

By repeated pressing on 'TRIP 2' you will get access to a number of registers that will give you automatic measurements on special stages. This is a great relief for the co-driver at the start and finish of special stages. By resetting TRIP 2 the automatic measurement of the length, time, top speed and average speed is initiated. The measurements will start automatically when the car is driven the first metre. When TRIP 2 shows its first metre a watch is started and from elapsed time and travelled distance the average speed is calculated continuously. At the finish of the stage you just press SPLIT and can then read the different values by pressing TRIP 2 repeatedly.

Action	Flash text	C-giant shows	Shown format
TRIP 2	.triP..2	Distance travelled	XXX.XXX
TRIP 2	.SS.Hour	Time since Trip2 started to count	XX.XX.XX
TRIP 2	.A.SPEEd	Average speed, calculated for Trip2 and .SS.Hour, unless flashing indicator (see below)	XXX.X
TRIP 2	.toP.SPd	Maximum speed	XXX

Except for maximum speed it is not possible to control this function in any other way than by changing TRIP 2. The maximum speed may be reset to zero separately. See also below for monitoring time of arrival.

5.1.5. Estimated time of arrival

By storing the length of your current road section (into the register for .EtA.diS) you can get your estimated time of arrival at either current speed or average speed. This function is useful when accessing the required speed on a particular road section and also working out the servicing time available. Select the function by repeatedly pressing TRIP 2.

You can also input the required time of arrival to give out the required average speed and your margin in time. This is done by inputting the required time into the register for .EtA.-A. and reading the required speed in the register for .A.SPEEd. Your margin in time in respect to your required time of arrival (positive or negative) at current speed is read in the register for .EtA.Cur. This function is indicated with a flashing indicator in the TRIP 2 key when you select .EtA.-A, .EtA.Cur or .A.SPEEd. This mode of operation is aborted by selecting .EtA.-A. and pressing the RESET key.

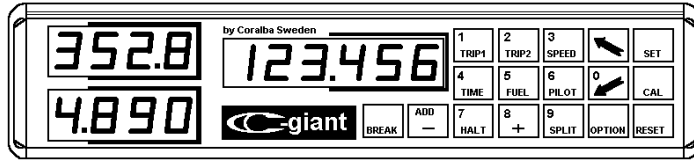

Action	Flash text	C-giant shows	Shown format
TRIP 2	.triP..2		
TRIP 2	.SS.Hour		
TRIP 2	.A.SPEEd		
TRIP 2	.toP.SPd		
TRIP 2	.EtA.diS	Length of current road section	xxx.xxx
TRIP 2	.EtA.-A.	Estimated time of arrival for Average speed calculated from .EtA.diS, .triP..2 and .A.SPEEd	xx.xx.xx
TRIP 2	.EtA.Cur	Estimated time of arrival calculated from .EtA.diS, .triP..2 and Current speed	xx.xx.xx

Also see page 18 for automatic SS measurement.

5.2. Speed measurement (SPEED)

If you want to see your current speed, simply press SPEED. The speed can be read in km/h or MPH depending on how you have set up the unit. See page 26 for set up. The value of the speed is frozen by SPLIT in the same way as for all other registers in the instrument. SPEED is also used to input desired speed for the PILOT to work with. See page 22.

5.2.1. Speed threshold (OPTION)

This option is aimed to get an indication when you exceed a pre-set speed threshold. You may select it by pressing SPEED three times. The value may be set to a desired value using the SET procedure. As soon as your speed exceeds that value an output signal is activated.

5.3. Set

As mentioned previously SET is used to set any register to a desired value. The register to be set is selected by pressing the appropriate key and thus making it visible in the display. To set the value simply press SET and you will see the figures in the display flash. This indicates that by using the numeric keys you may enter a new value. A negative value may be entered by preceding the value with (-). The input is finished by pressing SET again. The value is then visible in the display.

NOTE! if for any reason you wish to retrieve the original value – say if you made a mistake simply press RESET instead of the SET-key.

Adjusting a value

This function will adjust the value of any register that may be set with the normal SET procedure. Start a normal SET procedure by pressing 'SET'. Input the value to add but instead of confirming the input with 'SET' you confirm with the ADD key. Then the fed value is added (including a preceding minus sign if the value is negative) to the current register. If the register is to be decreased a minus sign (-) is fed in as a first sign in the value. In SET mode '-' will be interpreted as a minus sign if it is the first key after 'SET' otherwise it is interpreted as 'ADD'.

Example: Align trip to road book

You pass a junction at 34.98 km and you want to align C-giant to that value. At the junction you press RESET and carry on without stopping. Then you press SET, 34980, ADD/- and your input is added to the current value of the trip regardless of the distance you have travelled in the meantime. So the trip is aligned to the road book at the junction at 34.98 km.

NOTE! 'RESET' will reset .SS.Hour to zero if TRIP 2 is selected!

5.4. Time measuring (TIME)

The clocks may be used as an ordinary clock or a stop watch. It may stop (HALT), count up (+), down (-), freeze value (SPLIT), set or adjust value (SET) in the same way as described for TRIP above. All the features work the same on HOUR 1 and HOUR 2.

5.4.1. Set time

Action	C-giant shows
Press TIME (select TIME register)	Current time
Press SET (start input of value)	Current time flashes
Set time with numeric keys 0 to 9	New time flashes
Press SET (store with SET-key)	New time

5.4.2. Adjust time

It is very easy to adjust the time by any value: The same procedure as for trip meters is valid. For time the format of 24.59.59 is taken into account automatically.

Action	C-giant shows
Press TIME (select TIME register)	Current time
Press SET (start input of value)	Current time flashes
Input correction with numeric keys 0 to 9, (preceded by a '-' if negative)	Correction flashes
Press ADD	New time

If the clock is running too fast or too slow it is possible to calibrate it. See page 24.

5.5. Fuel gauge (FUEL)

This function will give information about the amount of fuel left in the tank. This feature must be calibrated before it is used. See page 24.

It is also possible to monitor the amount of fuel over the last 99 km's by using '+' and '-'. For each touch you will get the "*number of km since*" to the left in the display and the "*amount of fuel at that time*" to the right. This is important if you suspect a faulty fuel sender - the amount of fuel in the tank should have decreased constantly! It will also give you a rough idea of the fuel consumption.

5.6. Monitoring average speed (PILOT)

The Pilot is a useful tool to monitor your actual position in respect of the scheduled time. This is important when the road sections are long or some service is required on the car. By storing the required average speed into the SPEED register the time gained or time delayed is read in the PILOT register. The sequence is:

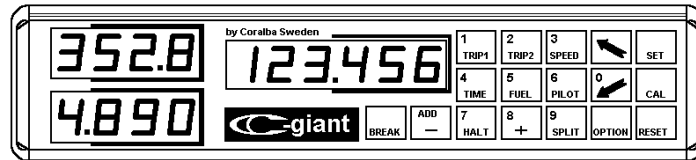

Store required average speed:

Action	C-giant shows
Press 'SPEED' (select SPEED register)	Speed of vehicle
Press 'SET' (start input of value)	Current PILOT-speed flashes
Set average speed with numeric keys	New PILOT-speed flashes
Press 'SET' (store with SET-key)	Current speed of vehicle

Unless you set the start value to zero with 'RESET' you set the PILOT register to its value with the normal SET and ADD procedures as described on pages 20 and 20:

SET procedure:

Action	C-giant shows
Press PILOT (select PILOT register)	Time gained or delayed
Press SET (start input of value)	Current time gained or delayed flashes
Set start value with numeric keys 0 to 9	Start value flashes
Press SET (store with SET-key)	Current time gained or delayed

This input may be done any time before start by setting time to start as gained time. Then the pilot will count down to zero at starting time.

Set the counting direction of the PILOT register to the desired counting direction with (+), (-) or HALT. NOTE!! These three keys only have an impact on the measuring of distance in the PILOT, **not on time measurement!**. An implication of this is that if you make a mistake and drive one part on a road section on a wrong road and you have to go back to the correct section again you just set the PILOT to (-) when you go back and it will give

you the correct penalty for your mistake. Don't forget to set it back to the (+) direction once you are back on the correct route again!

The PILOT calculates continuously the time gained or time delayed in respect to the stored average speed. If you are delayed the result is shown with a "-" in front of the time value. The format of the result is hour.min.sec (hh.mm.ss).

5.7. Calibrate C-giant, distance (CAL)

To enable the C-giant to measure accurately it must be calibrated. The dimensions of tyres, air pressure and transmission ratios influences the performance and therefore it is important to calibrate C-giant if these are altered.

If this is the first time you calibrate the unit then convince yourself that you have selected the desirable display mode (metres, feet, miles....km/h, MPH....). If not see page 26 for set up.

Then check tire pressure and inflate, as necessary, to manufacturers specifications.. Then you need to know the exact distance of your calibrating distance (this may be any value but for the best results it should be in excess of 0.999 km 999 feet or 0.999 miles). If you do not have access to an exact distance the local police force are usually quite prepared to advise you of a number of sites.

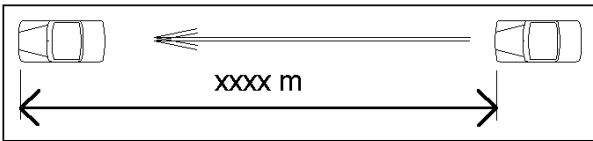
Procedure	C-giant shows
Select any trip meter or SPEED	Selected register
Press CAL	Current calibrating constant
Press CAL	Text .drive.
Drive the calibrating distance	".drive." and the calibrating constant flash alternatively.
	
Press SET (start input)	".LEngth"
Enter the length of calibrating distance	xxx.xxx
Press SET (store with SET-key)	New calibrating constant.

You have now calibrated your C-giant for distance and speed. The display mode may be changed as described at page 26 without calibrating the system again.

If the calibrating sequence has been carried out correctly and the distance used for this calibration was correct you will usually be able to measure to an accuracy better than 0.03% (30 cm/km).

Check the accuracy by travelling over your calibrating distance whilst measuring its length. If all factors are correct the length should correlate exactly.

Even if C-giant is disconnected from the power supply it will keep its calibrating constant in memory. Note the calibrating constant on a piece of paper together with information about current transmission ratios and tyres. Then you don't need to drive to get the instrument calibrated next time you use the same configuration. The value may of course be changed by using the standard SET procedure as described on page 20.

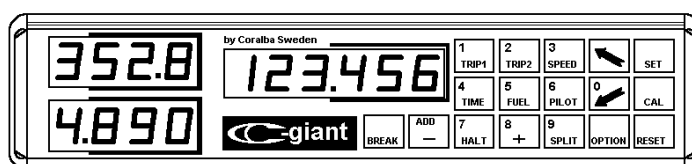

5.8. Calibrate C-giant (TIME)

The time is set with the normal SET procedure as described on page 20. If however time is running too fast or too slow it is possible to calibrate time. Select 'TIME' and then 'CAL'. Use '+' and '-' to set the number of seconds you want to adjust the time by over every 24 hour period. When the correct number is set you must store the value with 'SET'. To resume without changing - use 'RESET' instead of 'SET'.

Now C-giant is calibrated. Even if C-giant is disconnected from the power supply it will keep its calibrating constant in memory.

5.9. Calibrate C-giant (FUEL)

To calibrate the fuel gauge you must first of all select FUEL and check if its shown value is different when the engine is running compared to when it is stopped. If the values are different C-giant should be calibrated with the engine running. Start with the fuel tank almost empty. Then the amount of fuel in the tank must be stored in C-giant at the same time as it is filled up. This is done five times during filling. Note that a lot of gauges give a constant signal from empty tank to about five litres. This is because the float needs a certain level to float. This causes the C-giant to give a constant value.

□

Action	C-giant shows
Press FUEL	uncalibrated amount of fuel
Press CAL	.C.Pnt-1 flashes
Press SET	0 flashes
Input current amount of fuel in the tank. As the tank is almost empty you feed a "0"	0
Press SET	.C.Pnt-2 flashes
Fill about ten litres.	
Press SET	xx flashes
Feed the current amount of fuel in the tank (10)	10
Press SET	.C.Pnt-3 flashes
Fill about another fifteen litres.	
Press SET	xx flashes
Feed the current amount of fuel in the tank (25)	25
Press SET	.C.Pnt-4 flashes

Repeat until the tank is filled up and five values are stored.

*NOTE!! If you get the error indication Ad.-Err it means that the voltage from the fuel sender was unchanged for two calibration points. Is the ignition switched on?
If you get the error indication Fu.-Err it means that you didn't increase the amount of fuel between two calibration points.*

If you want to abort the sequence once you have started it – just press RESET before the sequence ends and the old values are restored.

Now the fuel gauge is calibrated. Even if C-giant is disconnected from the power supply it keeps it calibrating constant in its memory.

5.10. Set up units in C-giant

You may select different units for distance and speed in a special set up mode. Also the communication for a printer (option) may be set. From factory the unit is set up to the standard setting for your market. If you want to change units it is important to have your desired units set up before the calibration takes place. After the calibration has been carried out, the set up may be changed without re calibrating the unit.

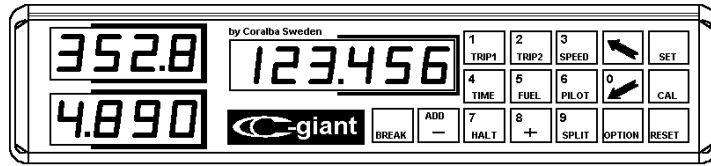

Procedure	C-giant shows
Select any trip meter or 'SPEED'	Selected register
Press 'CAL'	Current calibrating constant
Press 'RESET' (Enter set up mode)	.SEtUP. Indicator flashes
Press any of the selection keys as listed below	Flash text shows current setting
Press the same key once more to change	Flash text shows new setting and .SEt.UP. starts to flash, indicating that something has been changed
Repeat selection key until desired set up is ready	
Press SET (store with SET-key)	If something is changed you will be brought back to the 'BREAK' status. Otherwise to calibrating constant

You may exit any time from the set up mode without changing anything by pressing 'RESET'.

You have now set up your C-giant to show your desired units. Even if the instrument is disconnected from the power supply it keeps it set up in its memory.

The following selection keys and choices are available (the corresponding flash text is shown within brackets):

DISTANCE (selection key is 'TRIP1'):

- meters (MEtEr)
- miles (MiLES)
- miles + yards (Mil.yArd)
- feet (FEEt)
- nautical miles (nAutMil)

miles + feet (MiL.FEEt)

SPEED (selection key is 'SPEED'):

kilometres per hour (kiloM/h)
miles per hour (MPH)
metres per minute (M/Min)
feet per minute (Ft/Min)
knots (knotS)
metres per second (M/SEc)

For the connection of a printer or a computer (option) the set up of the communication may be of interest:

BAUD RATE (selection key is '+'):

br. 110, 300,600, 1200, 2400, 4800, **9600 (factory setting)**

CTS POLARITY (selection key is 'SPLIT'):

negative polarity (CtS.nEG) factory setting
positive polarity (CtS.PoS)

5.11. Split

SPLIT will freeze all registers values simultaneously permitting later inspection. All functions will carry on their counting. Flash text (..SPlit.) and led indicator shows that the function is selected. Second touch at 'SPLIT' will disable the freeze function and show current values.

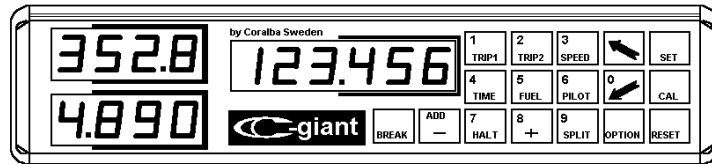

This function may be used any time during normal operation - not in SET or calibration mode.

5.12. Option

C-giant has got two remote lines (yellow and white cable) that may be used with default functions or with definitions made by the user. See page 7 and 8 on how to connect. 'OPTION' lets you define the functions for these control lines. The indicator in the key is on when at least one remote line is defined by the user. To clear a definition you just select the appropriate remote line (white or yellow) with 'OPTION' and press 'RESET'. The default functions are:

- White - reset TRIP 1 regardless of whether it is the current register or not
- Yellow - reverse the current counting direction of the trip meter.

To change the function of a remote control you just take the following actions:

Action	C-giant shows
Press OPTION	text (.OPtion then (.WhitE)
Press OPTION	Toggle between (.WhitE) and (.YellOw)
Press SET	Starts the definition
Sequence of keys to be computed each time selected remote is activated	Key codes
Press SET	Confirms the definition

If you change your mind before the definition is completed - just press 'RESET' to resume to previous definition. As the SET and RESET keys have special functions while defining the remote they cannot be defined as other keys. To include these keys in a definition you have to press 'OPTION' before the SET and RESET keys.

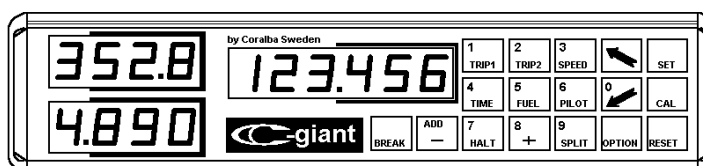

Example 1: Finish of special stage

At the finish of a special stage it is convenient to have a remote control defined to perform the following functions: Freeze, select time on stage, select time of day and select maximum speed. Just press the following keys.

Press	Result	Display
OPTION	Show selected remote line	.WhitE
OPTION	Show selected remote line	.YellOw
SET	Starts the definition for the yellow remote	blank display
SPLIT	Will split the instrument	1 C4 program step 1 and row C, column 4 for SPLIT
FUEL	Select FUEL as dummy before next key	2 b3
TRIP 2	Select TRIP 2	3 A3
TRIP 2	Select time on stage	4 A3
ARROW UP	Copy time on stage to upper left window	5 A5
TRIP 2	Select average speed on stage	6 A3
TRIP 2	Select maximum speed on stage	7 A3
ARROW DOWN	Copy maximum speed on stage to lower left window	8 b5
TIME	Select time of day	9 b2
SET	Confirms the definition	

When FUEL is selected in this example it is just in case TRIP 2 is already selected. If it is we would select the wrong register by just continuing pressing TRIP 2.

Example 2: Road section interval

During a road section it is convenient to have a remote control defined to perform the following functions: Reset and show interval distance, show total distance, select and show estimated time of arrival to next time control. Just press the following keys.

Press	Result	Display
OPTION	Show selected remote line	.WhitE
SET	Starts the definition for the white remote	blank display
FUEL	Select FUEL as dummy before next key	1 b3 program step 1 and row b, column 3 for FUEL
TRIP 1	Select TRIP 1	2 A2
OPTION	Prefix to allow RESET to be defined	2 A2
RESET	Reset TRIP 1	3 C6
TRIP 2	Select TRIP 2	4 A3
ARROW UP	Copy TRIP 2 to upper left window	5 A5
ARROW UP	Show TRIP 2 with 10 m resolution	6 A5
TRIP 2	Select time on stage	7 A3
TRIP 2	Select average speed on stage	8 A3
TRIP 2	Select maximum speed on stage	9 A3
TRIP 2	Select EtA-distance	10 A3
TRIP 2	Select EtA-A	11 A3
TRIP 2	Select Estimated Time of Arrival	12 A3
ARROW DOWN	Copy Estimated Time of Arrival to lower left window	13 b5
TRIP 1	Select TRIP 1	14 A2
SET	Confirms the definition	

When FUEL is selected in this example it is just in case TRIP 2 is already selected. If it is we would select the wrong register by just continuing pressing TRIP 2.

By using the two definitions above the co-driver doesn't need to have access to the trip meter while the car is running. Everything is done with the aid of the remote controls.

6. ERROR CODES

On some occasions an error code may appear in the display. The following codes are available:

Code	Reason	Action to be taken
Ad-Err	Voltage from the fuel sender was unchanged for two calibration points during fuel calibration.	Check connections for the black cable. The power supply must be ON to the fuel sender (Ignition key ON).
CALErr	Probably a bad connection for the power supply.	Recalibrate distance by driving the calibrating distance.
Fu-Err	You didn't increase the amount of fuel between two calibration points	Input a higher value for fuel for each calibration point.
PE-Err	Polarity of yellow cable changed at a speed of at least 10 km/h.	Check connection of yellow cable. If it is connected to a remote control it should be defined before you use it. See page 27.
SU-Err	Probably a bad connection for the power supply.	Consult Jemba for service.

7. INDEX

- , 15
- +, 15
- accident, 8
- accuracy, 24
- Ad.-Err, 25; 31
- ADD, 15
- ADD, 20
- adjust time, 21
- adjusting a value, 20
- align trip, 17; 20
- arrow down, 14
- arrow up, 13
- automatic SS
- measurements, 18
- average speed, 18; 22
- battery, 7
- BAUD RATE, 27
- BREAK, 9; 15
- CAL, 23
- CAL, 14
- calibrate distance, 23
- calibrate FUEL, 24
- calibrate TIME, 24
- calibrate time, 24
- clock, 14
- communication, 27
- connect fuel, 8
- connections, 7
- counting direction, 15
- define remote, 27
- delayed time, 14
- display, 9
- display mode, 9
- distances measurement, 17
- disturbances, 7
- electrical connections, 7
- electronic
- speedometer, 5
- electronic
- speedometer, 4
- emergency, 15
- error code, 31
- estimated time of
- arrival, 18
- failure, 15
- feet, 27
- fitting, 4
- fitting pulse generator, 4
- freeze, 16; 27
- Fu.-Err, 25; 31
- FUEL, 21
- FUEL, 14
- fuel calibration, 24
- fuel connection, 8
- fuel consumption, 21
- fuel gauge, 7
- functions, 9; 10
- fuse, 7
- ground, 7
- HALT, 15
- junction, 17
- keyboard, 9
- measuring distances, 17
- memory, 24; 26
- memory, 10; 17
- meters, 26
- miles, 26
- minus, 20
- MPH, 27
- nautical miles, 27
- numeric input, 9
- numeric keys, 17
- OFF, 9
- ON/OFF, 9
- OPTION, 16; 27
- PG-Err, 31
- PILOT, 13
- PILOT, 14; 22
- POSITIVE, 15
- power, 7
- power, 9
- power supply, 7
- pre-set, 17
- printer, 27
- remote, 16
- remote control, 8
- remote control, 27
- remote lines, 27
- remote reset button, 7
- required speed, 10
- RESET, 16
- resolution, 14
- reverse, 7
- reverse light, 7; 8
- road book, 20
- S.U.-Err, 31
- safety, 8
- scheduled speed, 14
- SET, 13; 20
- set distance, 17
- set time, 21
- set up units, 26
- speed, 13
- speed threshold, 19
- SPLIT, 16; 27
- stop counting, 15
- stop watch, 14
- target time, 10
- TIME, 14
- time measuring, 20
- time of arrival, 18
- tolerance, 3
- top speed, 18
- TRIP, 13
- TRIP, 17
- turn on, 9
- yards, 26
- yellow remote control, 8
- zero, 16